

# COBRA 3.1



## Set of Equipment supplied

- 1 **Cobra 3.1** fog generator incl. Duct Adaptor/Protection against contact
- 1 Tank lid with Quick Connector
- 1 mains cable 2 m with Powercon True plug
- 1 Operating manual

Please check whether all the products you ordered are supplied.

# Content

<b>1. Introduction</b>	<b>4</b>
<b>2. Safety instructions</b>	<b>5</b>
<b>3. Description of the parts</b>	<b>6</b>
3.1 Wiring of the connectors	7
<b>4. Fluid</b>	<b>8</b>
4.1 General Notes	8
4.2 Changing the fluid container	8
<b>5. Operating the Cobra 3.1</b>	<b>9</b>
5.1 Selecting the location	9
5.2 Putting into operation	9
5.3 Switching off	9
5.4 Operation	<b>10</b>
5.4.1 Main menu	10
5.4.2 Status bar	11
5.4.3 Display Standby	12
5.4.4 Display Tank empty	12
5.5 Working with Sources	<b>13</b>
5.5.1 Manual operation	14
5.5.2 Operation via DMX	14
5.5.3 Operation via analog	16
5.5.4 sACN	18
5.5.5 Art-Net	19
5.5.6 Operation via Timer	21
5.5.7 RDM	23
5.6 Settings	<b>24</b>
5.6.1 Fog Curve	25
5.6.2 Personality	26
5.6.3 Ethernet	27
5.6.4 Display	28
5.6.5 Fluid Detection	28
5.6.6 Pump adjustment	29
5.6.7 Standby	29
5.6.8 Info	30
5.6.9 Update	30
5.6.10 Reset	30
5.7 DMX-Channel assignment	<b>31</b>
5.8 Software-Update	<b>32</b>
<b>6. Troubleshooting and Error messages</b>	<b>33</b>
6.1 Malfunction during operation	33
6.2 Error messages	34
<b>7. Cleaning, Care and Maintenance</b>	<b>35</b>
<b>8. Specifications</b>	<b>36</b>
<b>9. Warranty conditions</b>	<b>37</b>

# 1. Introduction

The **Cobra 3.1** is a powerful fog generator, that sets new Standards concerning noise and handling.

With its novel nozzle, that can be unscrewed and cleaned as needed, the machine is very silent - the noise level at full output is 82.5 dBA.

The use of two pumps ensures a very constant fog output at any pump level.

The Touchscreen makes the handling of the **Cobra 3.1** easy and intuitive.

Beside the analog and DMX 512 control, the machine can also be operated via Ethernet (Artnet and sACN).

Furthermore, the **Cobra 3.1** has an internal working hours counter, that saves heating and fogging durations.

A Firmware update can be made by the customer.

The machine is supplied with a duct adaptor that also functions as a protection against contact.

**Please read the manual carefully before starting the device to ensure a correct operation!**

## 2. Safety instructions

### A fog machine is not a toy!

- Very hot steam escapes from the nozzle. Danger of getting burnt.
- Occasionally very hot droplets of fluid may escape when in operation. Thus never aim at persons directly and keep a minimum distance of 3 m to the nozzle.
- Never touch the nozzle when in operation. Danger of getting burnt.
- The location for the machine must be non-flammable, non-combustible and not sensitive to heat. It has to be twice as big as the machine.
- Keep a minimum distance of 60 cm to all flammable, combustible objects and objects sensitive to heat.
- Glycol is alcohol and burns with a slightly bluish, almost invisible flame. Never point the fog at strong sources of ignition like fire or pyrotechnic effects.
- Never open the machine and leave the machine unattended when connected to a power supply.
- It is only allowed to fly/hang the machine by using the original hanging set.
- The visibility has to be more than 2 m in rooms where people walk around.
- Do not swallow the fog fluid. Keep it away from children. In case of eye contact, rinse with a lot of water. Consult a doctor should you have accidentally swallowed some fluid.
- Spilled fluid or splashed fluid droplets can cause slip hazard. Mop up the fluid and dispose of it according to regulations.
- Fog may activate smoke detectors.

Artificially-made fog can be produced in many different ways. The method used here to produce fog, with a device which works according to the vaporizer principle, is the most harmless one.

No case has so far been reported in which a sound human being has been harmed because of using our device to produce artificial fog. However, this can only be guaranteed if the professional fog generators are used accordingly, i.e. at the correct vaporization temperatures as well as with the correctly mixed fog fluid.

We, however, recommend: **People with health problems or problems of the respiratory tract or with an inclination for allergies should avoid any contact with artificially-made fog.**

### 3. Description of the parts

Front view

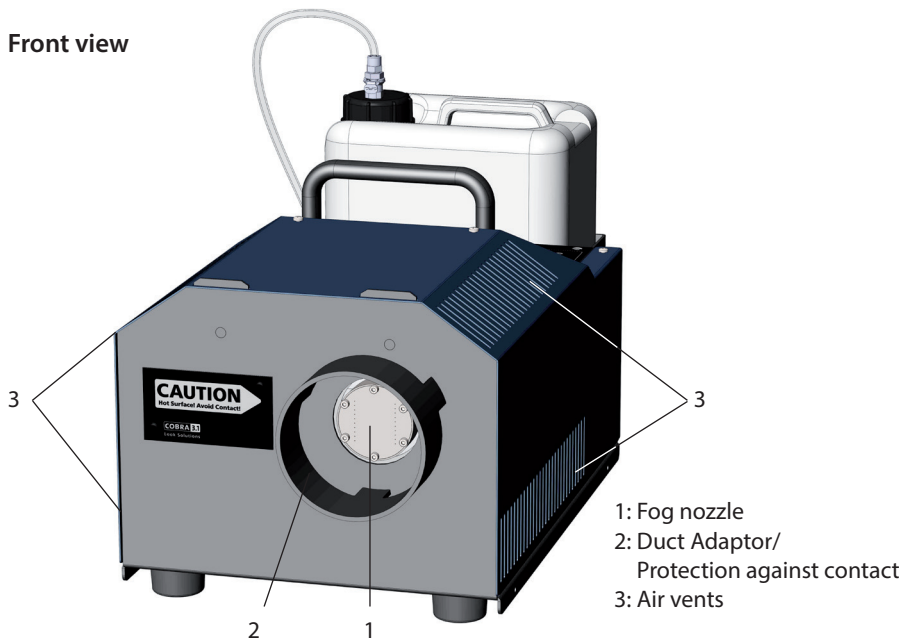

Tank lid

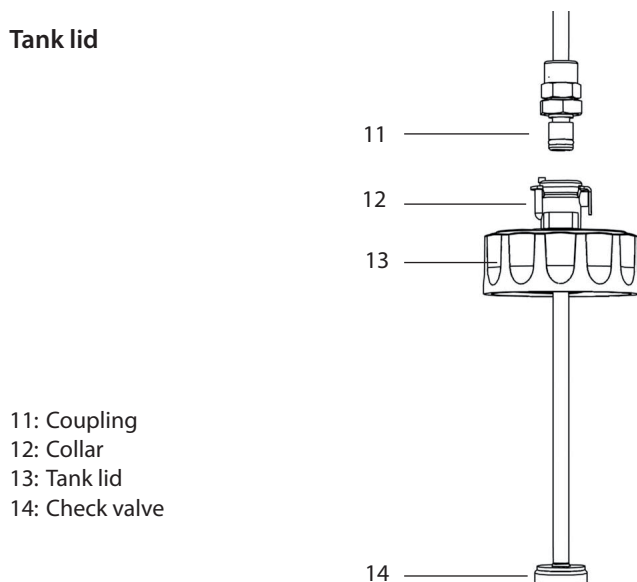

## 3. Description of the parts

### Rear view

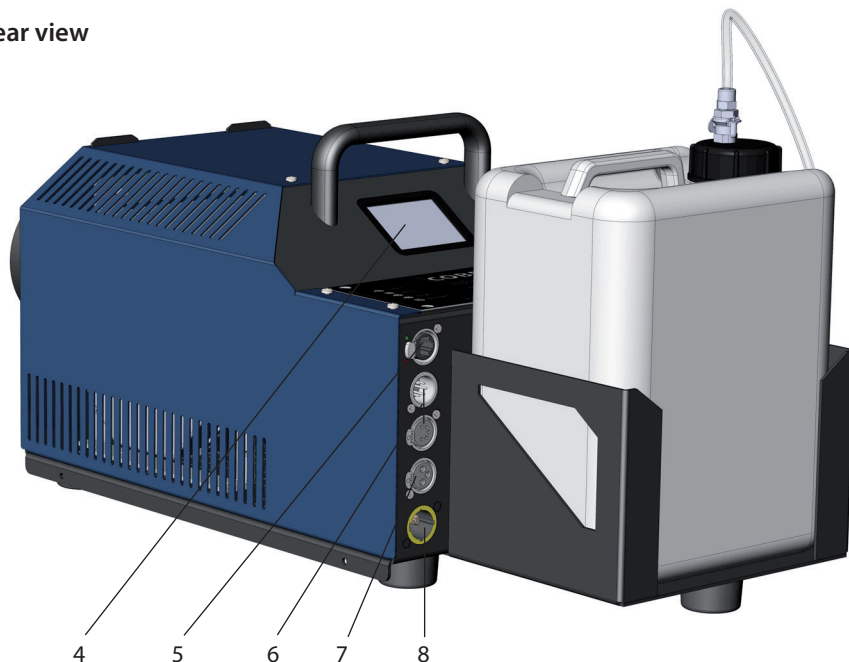

4: Touchscreen/Control Panel  
5: Ethernet-Connector RJ45/Ethercon  
6: DMX512 in/out 5pin-XLR

7: Analog in 3pin-XLR  
8: Power in/out for Powercon True plug

### 3.1 Wiring of the connectors

#### 5-pin XLR (DMX):

Pin 1 = Ground, Pin 2 = DMX -, Pin 3 = DMX +, Pin 4 u. 5 = nc

#### 3-pin XLR (analog):

Pin 1 = Ground, Pin 2 = 0-10 V + DC in, Pin 3 = 12 V + DC out, max. 50 mA

## 4. Fluid

### 4.1 General Notes

The **Cobra 3.1** has been designed to be used with Look fog fluids.

The following Look fog fluids are available:

Quick-Fog	thick, quick disappearing fog fluid
Regular-Fog	thick, long lasting fog fluid
Slow-Fog	thick, extremely long lasting fog fluid

If fluids have been used other than Look fog fluids we can't grant warranty.

**PLEASE NOTE:** The vaporizer of our machines does not have to be cleaned! Cleaners, available on the market, can damage the vaporizer! We cannot grant warranty in this case.

### 4.2 Changing the fluid bottle

- Disconnect the fluid tube from the lid by pressing the lever on the collar [12] and removing the coupling [11].
- Remove the bottle from the tank housing of the **Cobra 3.1**
- Unscrew the lid [13] of the empty bottle and screw it onto the new container.
- Place the full can into the tank housing.
- Push the coupling [11] into the collar [12] until you hear a click. The collar is now locked firmly.



## 5. Operating the Cobra 3.1

### 5.1 Selecting the location

The location in which the **Cobra 3.1** is to be operated must

- be dry,
- be free from dusty or polluted air,
- be free from vibrations,
- be a non-flammable place or surface,
- be well-ventilated with fog-free air keeping the ambient operating temperature between 5° C and 45° C and the relative air humidity below 80%.

### 5.2 Putting into operation

- Connect a fluid canister to the unit.
- Connect - if needed - cables for external control like DMX, Ethernet or a remote control. Use the connectors [5], [6] and [7] on the back of the unit.

#### Note

Use only suitable cables for connection!

DMX cables must be suitable and shielded for digital data transmission!

Ethernet cables must be at least category 5e and shielded!

- Now insert the plug of the supplied PowerCon mains cable into the connection provided [8] and turn the plug until it audibly clicks into place. Then connect the mains plug to an earthed socket. Make sure that the correct operating voltage (230 V/50 Hz) is applied.

#### Warning

Use only the enclosed power cable or another cable approved by the manufacturer!

Connect the machine only to grounded sockets!

- The fog generator needs approx. 10 Min. to heat-up. Wait for this time to elapse. The **Cobra 3.1** is now ready for operation.

### 5.3 Switching off

- Unplug the power cord from the socket and/or remove the PowerCon True1 plug from the connector on the unit.

## 5. Operating the Cobra 3.1

### 5.4 Operation

#### 5.4.1 Main menu

After switching the device on, the main menu appears.



Fig. 1: Main menu - Cobra 3.1 when heating up

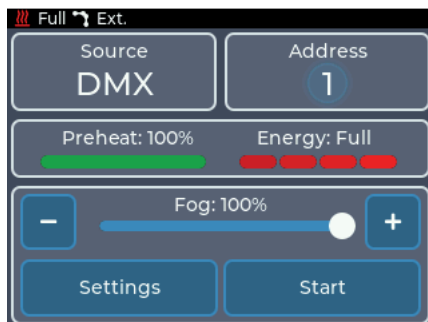

Fig. 2: Main menu - Cobra 3.1 ready for operation

The main menu is divided into several sections, each of which contains specific information or settings:

- **Top left: Source**  
Shows the currently active source. Tapping leads to the Select source menu. Using sources is described in section 5.5.
- **Top right: Information about the chosen Source**  
Tapping leads to the settings menu of the active source. If the center is highlighted, a valid signal is received from the source. The information displayed is described for the individual sources.
- **Middle: Status display**  
Displays information on the heating status of the machine. **Preheat** indicates how far the machine has heated up to the point where it is ready for operation. **Energy** indicates how much energy is available in the heating element for vaporization.
- **Bottom: Adjustments and manual operation**  
Tapping **Settings** leads to the settings menu.  
Manual operation is described in section 5.5.1. When the source is active, the current fog setting is displayed on the slider.

# 5. Operating the Cobra 3.1

## 5.4.2 Status bar



Fig. 3: Status bar showing all symbols

The status bar is always at the top of the display and shows the most important information. These are from left to right:

- Heating status (🔥): Indicates the Preheat state with blue symbol or the Energy state with red symbol
- Pump curve (📉): Shows the current pump characteristics
- Analog icon (📡): Indicates if a signal from a remote control is present
- DMX icon (🎭): Indicates if a DMX signal is received
- Art-Net icon (<A>): Indicates whether Art-Net data is being received.
- sACN icon (<S>): Indicates whether sACN data is being received.
- Ethernet icon (<>): Indicates the status of Ethernet.
  - Icon without IP address: Connected, but no IP address available.
  - Icon and IP address: Connected and valid IP address available.
  - Red: Connected, but no IP address obtained via DHCP.
- Timer icon (🕒): Indicates whether the integrated timer is running.

## 5. Operating the Cobra 3.1

### 5.4.3 Standby display

If the signal of the active source is lost, the **Cobra 3.1** will go into standby. The pump and heating element are switched off and the display switches to the screen saver.

Before the device goes into to standby, the display shows a note with a countdown of 10 seconds.



Fig. 4: Standby display

The device can also be switched to standby via the settings menu.

To exit standby,

- touch the display
- reconnect the current source

If the DMX-Personality is set to 3-channel mode, the standby can be entered and exited via channel 3 (see section 5.6.2).

### 5.4.4 Display Fluid empty

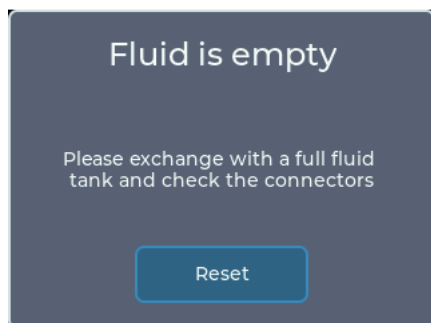

Fig. 5: Display Fluid empty

This note will only be displayed if the fluid detection is switched on (see section 5.6.5).

If the pump runs dry for a longer period of time, it is stopped and a note is displayed.

The fluid detection works from a pump setting of 20 % and higher.

To reactivate the pump, **Reset** must be tapped on the display.

## 5. Operating the Cobra 3.1

### 5.5 Working with sources

In version 3 of **Cobra 3.1**, the previous hierarchical system is replaced by a system with source selection, which is based on the source selection on a TV, for example.

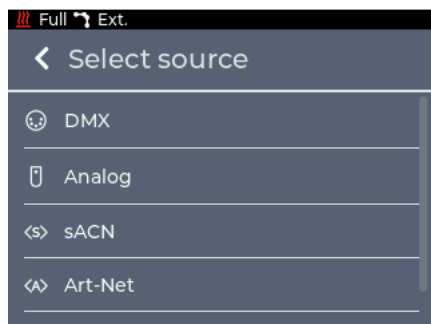

Fig.. 6: Menu Sources

Basically, a set source is used until it is changed on the device. However, there are some exceptions to this rule:

1. **DMX** is selected as source  
If the DMX signal is lost and the analog remote control is used, the source is automatically changed to analog.
2. **Analog** is selected as source  
When the machine receives a DMX signal again, the source is automatically changed to DMX
3. **Timer** is selected as source  
When the machine receives a DMX signal again, the source is automatically changed to DMX
4. **Manual operation** via display  
Manual operation is only possible if the selected source is not active. If it becomes active, manual operation is automatically terminated.

## 5. Operating the Cobra 3.1

### 5.5.1 Manual operation

If no source is active, the device can be operated manually via the main menu.

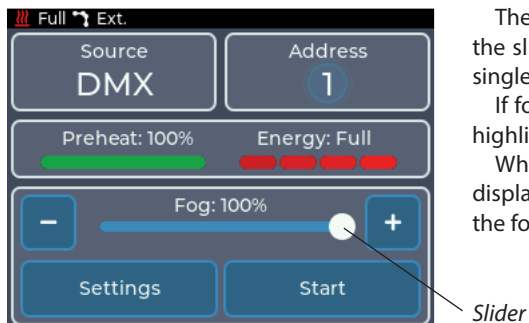

The desired amount of fog can be set via the slider. The quantity can be adjusted in single steps with the + and - keys.

If fogging is possible, the Start button is highlighted and can be tapped.

While the machine is fogging, Stop is displayed on this button. Tapping it causes the fogging process to stop.

Fig. 7: Manual operation

**Please note** that the selected pump characteristic has an influence on the fog quantity. This means that even when manually set to 100%, less fog may be produced. For more information, see section 5.6.1.

If Continuous is set as the pump characteristic, the display is limited to 30%.

### 5.5.2 Operating via DMX

The source setting **DMX** is the default of the machine. The main menu displays the current DMX address and the status of the DMX connection.



Fig. 8: Main menu DMX

By tapping the **DMX** button or by **Source** -> **DMX** it is possible to switch to the DMX settings menu.

Here the DMX address can be set.

## 5. Operating the Cobra 3.1



Fig. 9: DMX settings

The device needs between one and three DMX channels. The number of channels can be changed via the **Personality** setting, see section 5.6.2.

**Please note** that the selected pump characteristic has an influence on the fog quantity. This means that even with a DMX value of 100%, less fog may be produced. For more information, see section 5.6.1.

The **Cobra 3.1** supports RDM in DMX mode. More about this in section 5.5.7.

## 5. Operating the Cobra 3.1

### 5.5.3 Operating via Analog

The **Analog** source setting can be used to control the machine via a remote control. The current Analog mode and status are displayed in the main menu.



Fig. 10: Main menu Analog

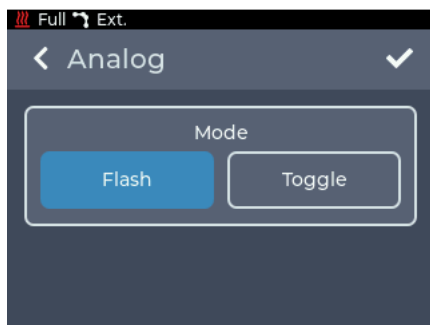

Fig. 11: Setting Flash

In **Flash** mode, the fog output is set linearly with the input voltage between 0 and the maximum pump value. It corresponds to the DIRECT mode on the version 1 and 2 devices.

The maximum pump value can be set in the main menu when the remote control is not active, using the slider in the lower section.

It is recommended to set the pump value (FOG) to 100% so that the full fog output can be used. If the value is preset to e.g. 65%, the connected remote/desk controls between 0 and 65% as maximum value.

The pump is started from approx. 1V at the analog input.

When using the available radio remote control, the start button must be kept permanently pressed with this setting.



## 5. Operating the Cobra 3.1

The **Flash** mode is preset by default. It is recommended to use the **Toggle** mode only when using the radio remote control.

The advantage here is that the start button on the transmitter does not have to be held down permanently.

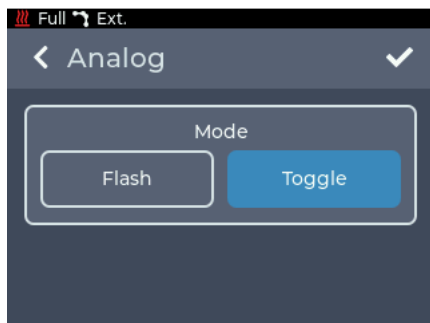

Fig. 12: Setting Toggle

In **Toggle** mode, briefly pressing the Start button on the transmitter of the radio remote control starts the output.

Another short press ends the output.

The Toggle mode corresponds to the LATCHED mode on the version 1 and 2 devices.

This allows the available radio remote control to be used in combination with the device without having to keep the start button on the remote control permanently pressed.

It is also recommended to set the pump value (FOG) to 100% so that the full fog output can be used. If the value is preset to e.g. 65%, the connected remote/desk controls between 0 and 65% as maximum value.

### Note

In contrast to the devices version 1 and 2 the toggle mode can also be terminated by switching to flash mode or changing the source.

- Pressing < in the upper left corner returns to the previous screen without saving the changes.
- Pressing ✓ saves the settings and returns to the main menu. Analog is now selected as the source.

**Please note** that the selected pump characteristic has an influence on the fog quantity. This means that even when manually set to 100%, less fog may be produced. For more information, see section 5.6.1.

## 5. Operating the Cobra 3.1

### 5.5.4 sACN

The **sACN** source setting allows the **Cobra 3.1** to be controlled via network using the sACN protocol. The main menu displays the current sACN universe, the start address and the status of the connection.



Fig. 13: Main menu sACN



Fig. 14: Adjustments sACN

- Pressing < in the upper left corner returns to the previous screen without saving the changes.
- Pressing ✓ saves the settings and returns to the main menu. sACN is now selected as the source.

To receive sACN data, the **Cobra 3.1** must be connected to a network and have a valid IP address. The settings for this are described in section 5.6.3.

The device needs between one and three DMX channels. The number of channels can be changed via the **Personality** setting, see section 5.6.2.

By tapping the sACN button or by **Source** -> **sACN** it is possible to switch to the sACN settings menu.

Here the universe and the address can be configured.

By pressing + and - the number at the flashing cursor can be increased or decreased.

By pressing < and > or directly tapping a digit, the cursor can be moved.

In the upper row the **sACN universe** is set. The value can be between 1 and 63999.

In the lower row the **DMX-address** of the device in the selected universe is set. The value can be between 1 and 512.

## 5. Operating the Cobra 3.1

**Please note** that the selected pump characteristic has an influence on the fog quantity. This means that even when manually set to 100%, less fog may be produced. For more information, see section 5.6.1.

### 5.5.5 Art-Net

The **Art-Net** source setting allows the unit to be controlled via the Art-Net protocol by network. The current Art-Net configuration and the status of the connection are displayed in the main menu.

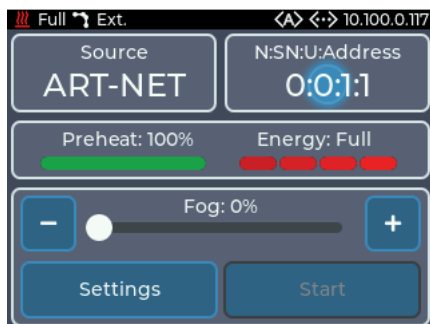

Fig. 15: Main menu Art-Net

By tapping the **Art-Net** button or by **Source -> Art-Net** it is possible to switch to the Art-Net settings menu.

Here the **Net**, **Sub-Net**, **Universe** and the **Address** can be adjusted.

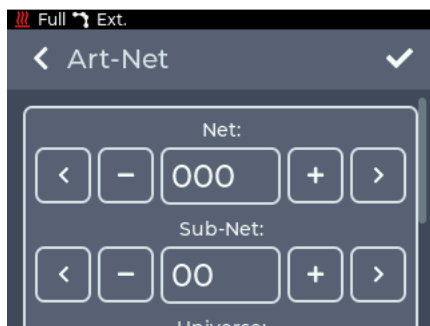

Fig. 16: Settings Art-Net upper section



Fig. 17: Settings Art-Net lower section

By pressing + and - the number at the flashing cursor can be increased or decreased. By pressing < and > or directly tapping a digit, the cursor can be moved.

In the upper row the **Art-Net Net** is set. The value can be between 0 and 127.

The **Art-Net Sub-Net** is set in the next row. The value can be between 0 and 15.

In the following row the **Art-Net Universe** is set. The value can be between 0 and 15.

## 5. Operating the Cobra 3.1

In the lower row the **DMX address** of the device in the selected universe is set. The value can be between 1 and 512.

- Pressing < in the upper left corner returns to the previous screen without saving the changes.
- Pressing ✓ saves the settings and returns to the main menu. Art-Net is now selected as the source.

To receive Art-Net data, the **Cobra 3.1** must be connected to a network and have a valid IP address. The settings for this are described in section 5.6.3.

The device needs between one and three DMX channels. The number of channels can be changed via the **Personality** setting, see section 5.6.2.

**Please note** that the selected pump characteristic has an influence on the fog quantity. This means that even when manually set to 100%, less fog may be produced. For more information, see section 5.6.1.

The **Cobra 3.1** supports RDM in Art-Net mode. For more information see section 5.5.7.

## 5. Operating the Cobra 3.1

### 5.5.6 Operating via Timer

The source setting **Timer** can be used to control the device via an integrated timer. The current status of the timer is displayed in the main menu. If the timer is running, the fogging and waiting time is displayed.



Fig. 18: Main menu Timer

By tapping the **Timer** button or by **Source -> Timer** you can switch to the Timer settings menu.

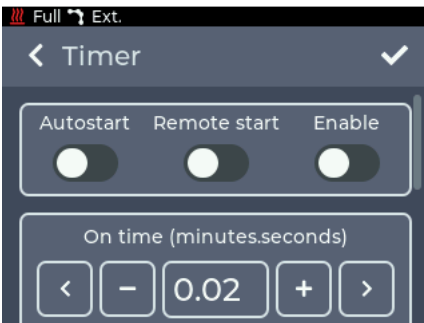

Fig.. 19: Setting Timer

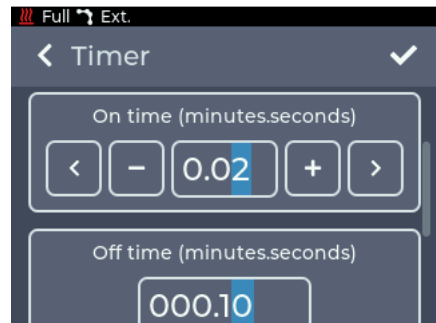

Fig. 20: Setting Timer On time

In the top box (Fig. 19), the start options can be changed:

- **Autostart:** After heating up the device, the timer starts automatically.
- **Remote start:** The timer is started by a short impulse at the analog input and continues to run normally.
- **Enable:** After saving the settings, the timer starts running.

By scrolling, the **On time** for the timer can be configured in the second box (Fig. 20). The time can be set between 2 seconds and 4 minutes.

By pressing + and - the number on the flashing cursor can be increased or decreased, by pressing < and > or directly tapping a digit the cursor can be moved.

## 5. Operating the Cobra 3.1

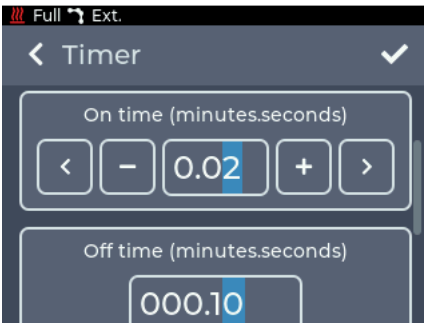

Fig. 21: Setting Timer Off time



Fig. 22: Setting Timer Fog Intensity

By scrolling, the **Off time** for the timer can be configured in the third box (Fig. 21). The time can be set between 10 seconds and 120 minutes.

By scrolling, the amount of fog (**Fog Intensity**) can be set in the fourth box (Fig. 22). The setting is made as in the main screen in the manual area (Fig. 7, p. 14).

- Pressing < in the upper left corner returns to the previous screen without saving the changes.
- Pressing ✓ saves the settings and returns to the main menu. The Timer is now selected as the source.  
If the **Enable** option is activated, the timer will start.

If the info area for the timer is tapped in the main menu while the timer is running, the timer will be stopped.

If you tap on the info area again while the timer is stopped, the timer settings menu will appear.

**Please note** that the selected pump characteristic has an influence on the fog quantity. This means that even when manually set to 100%, less fog may be produced. For more information, see section 5.6.1.

## 5. Operating the Cobra 3.1

### 5.5.7 RDM

When used with DMX and Art-Net, the **Cobra 3.1** supports the RDM protocol. Via RDM properties can be read and changed.

The following parameters are supported:

Parameter	Disc	GET	SET
DISC_UNIQUE_BRANCH	✓		
DISC_MUTE	✓		
DISC_UN_MUTE	✓		
QUEUED_MESSAGE		✓	
STATUS_MESSAGES		✓	
SUPPORTED_PARAMETERS		✓	
DEVICE_INFO		✓	
DEVICE_MODEL_DESCRIPTION		✓	
MANUFACTURER_LABEL		✓	
DEVICE_LABEL		✓	✓
SOFTWARE_VERSION_LABEL		✓	
DMX_PERSONALITY*		✓	✓
DMX_PERSONALITY_DESCRIPTION		✓	
DMX_START_ADDRESS		✓	✓
SLOT_INFO		✓	
SLOT_DESCRIPTION		✓	
DEFAULT_SLOT_VALUE		✓	
SENSOR_DEFINITION		✓	
SENSOR_VALUE		✓	✓
DEVICE_HOURS		✓	
DISPLAY_LEVEL		✓	✓
IDENTIFY_DEVICE		✓	✓
RESET_DEVICE		✓	✓

*\*DMX Personalities are described in section 5.6.2 (p. 26).*

### Sensors

The machine has the following sensors that can be read out via RDM:

- **Preheat %:** Mirrors the value from the main menu and status bar. Indicates the percentage until the machine is ready for operation.
- **Energy %:** Mirrors the value from the main menu and the status bar. Indicates how much energy is available to the heating block for evaporation. Will only show the values 0, 33, 66 and 100.
- **Heater Temperature:** Indicates the temperature of the heating element in °C. Can also be taken from the display under Settings -> Info -> Additional information (see section 5.6.8).
- **Fluid empty:** Indicates whether the tank has been detected as empty. Returns 0 for "Tank is not empty", 1 for "Tank is empty". If the tank is recognised as empty, the Cobra 3.1 switches off.

# 5. Operating the Cobra 3.1

## 5.6 Settings

By tapping the **Settings** button in the main menu, you can switch to the settings menu. All general settings can be adjusted here.

To get to the respective sub-item, scroll through the Settings menu and select the desired item by briefly tapping on it.

To return to the main menu, < must be pressed in the upper left corner.

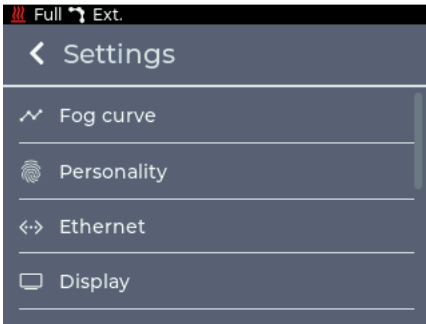

Fig. 22: Settings menu - upper section

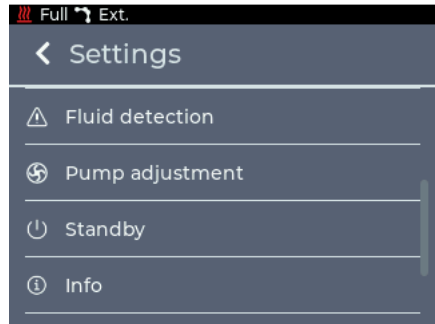

Fig. 23: Settings menu - middle section

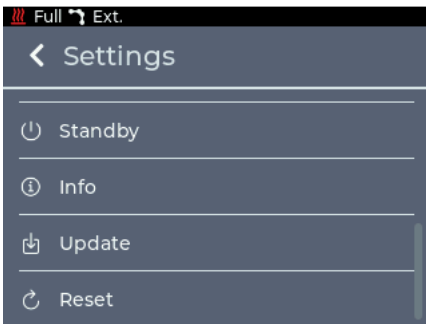

Fig. 24: Settings menu - lower section

The following pages describe the individual settings shown in Figs. 22 to 24 with the associated screen for each.



## 5. Operating the Cobra 3.1

### 5.6.1 Fog Curve

In the **Fog Curve** menu, the pump curve/characteristic can be adjusted. Depending on the selected curve/characteristic, fog output and fog time change.

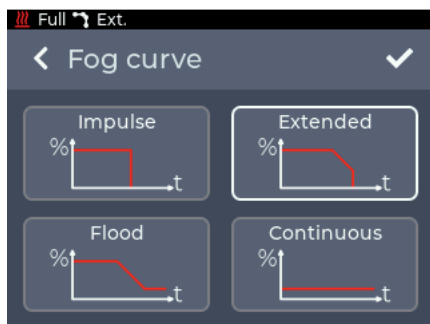

Fig. 25: Settings Fog Curve

The following settings are available:

- **Impulse:** The pump always fogs with the set value without the output being regulated down. When the shut-off temperature is reached (heating element too cold), the pump is switched off and the fogging process is terminated until the machine has reheated.
- **Extended:** This mode also starts with the set pump value. If the temperature in the heating element drops, the pump is regulated down slightly.
- **Flood:** This mode also starts with the set pump value. If the temperature in the heating element drops, the pump is regulated down to such an extent that the fog output changes to continuous fog. The machine thus starts with a high output and then regulates itself down to continuous fog. The fogging process will not stop in this case.
- **Continuous:** The pump is limited to 30 % to guarantee continuous fog.

**Note:** Of course you can also set a continuous fog function in **IMPULSE** or **EXTENDED** mode. The **Cobra 3.1** is capable of continuous fogging up to pump settings of approx. 35%. To do this, use the slider in the main screen to set the fog quantity to a maximum of 35.

If the **Personality** (section 5.6.2) of the **Cobra 3.1** has been set to two or three channels, the second DMX channel controls the pump curve. In this case, when the source is active, the externally set curve will override the saved curve. If the signal of the source is lost, the previously saved curve will be restored.

- Pressing < in the upper left corner returns to the previous screen without saving the changes.
- Pressing ✓ saves the settings and returns to the main menu.

## 5. Operating the Cobra 3.1

Pump setting	Fog time in sec. (Minimum data, if Energy = Full)	
	<i>IMPULSE-MODE</i>	<i>EXTENDED-MODE</i>
100 %	22 s	55 s
90 %	40 s	76 s
80 %	55 s	95 s
70 %	89 s	128 s
60 %	112 s	176 s
50 %	167 s	347 s
40 %	378 s	more than 10 min/
30 %	continuous output	continuous output

### 5.6.2 Personality

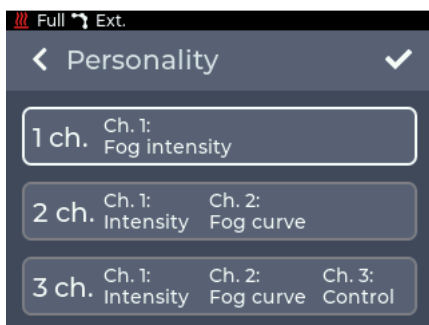

Fig. 26: Setting Personality

In the menu **Personality** the number of DMX channels can be adjusted. This setting can also be done via RDM (see section 5.5.1).

The DMX channel assignment is described in section 5.7.

The following settings are available:

• **1 ch.:**

Channel 1: Fog intensity = fog output

• **2 ch.:**

Channel 1: Fog intensity = fog output

Channel 2: Fog curve = pump characteristic (Impulse/Extended/Flood/Continuous), 5.6.1

• **3 ch.:**

Channel 1: Fog intensity = fog output

Channel 2: Fog curve = pump characteristic (Impulse/Extended/Flood/Continuous), 5.6.1

Channel 3: Control = Activate or deactivate standby via DMX

- Pressing < in the upper left corner returns to the previous screen without saving the changes.
- Pressing ✓ saves the settings and returns to the main menu.

## 5. Operating the Cobra 3.1

### 5.6.3 Ethernet

In the **Ethernet** menu, settings for the network connection such as DHCP or a static IP address can be configured.

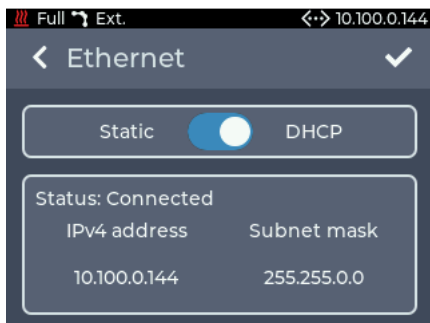

Fig. 27: Setting Ethernet - DHCP

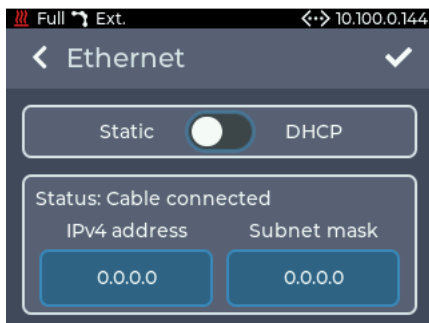

Fig.. 28: Setting Ethernet - Static

The upper switch can be used to set whether an IP address is to be obtained via DHCP or whether a static IP address is to be configured.

If **DHCP** is selected as the setting, the IP address and subnet mask assigned by the DHCP server in the network are displayed below.

If **Static** is selected as the setting, buttons for entering the IP address and subnet mask are displayed below.

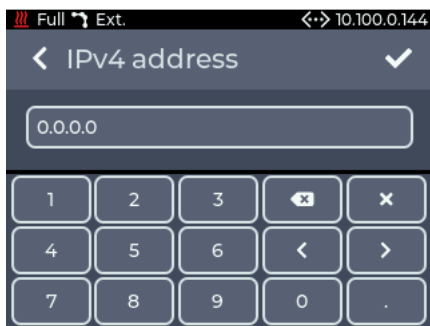

Fig. 29: Setting Ethernet - Manual address

If the buttons are tapped, a keyboard for entering the IP address or subnet mask is displayed.

- Pressing < in the upper left corner returns to the previous screen without saving the changes.
- Pressing ✓ saves the settings and returns to the main menu.

If a non-valid address is entered, the previous address is kept!

If no server in the network responds when **DHCP** is set, a random IP address is selected after approx. 15 seconds according to the Auto IP protocol. An attempt is still made to obtain an address from a DHCP server.

## 5. Operating the Cobra 3.1

### 5.6.4 Display

Brightness and screen saver can be configured in the **Display** menu.

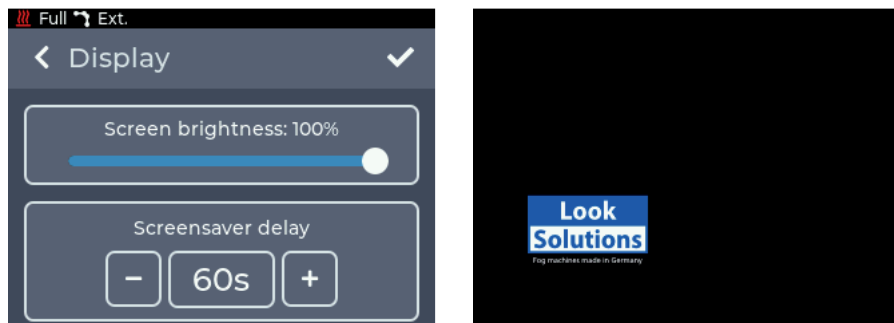

Fig. 30: Setting Display - Brightness and screen saver

In the upper area, the brightness of the display can be set in 10% steps between 10% and 100%. The time after which the screen saver is activated can be set in the lower area. A setting from 20 sec. to 120 sec. in 10 sec. steps is possible.

- Pressing < in the upper left corner returns to the previous screen without saving the changes.
- Pressing ✓ saves the settings and returns to the main menu.  
While the screen saver is active, touching the screen will restore the display.

### 5.6.5 Fluid Detection

In the **Fluid detection** menu, the fluid detection of the tank can be activated and deactivated. Deactivating the fluid detection will void the warranty of the pump.

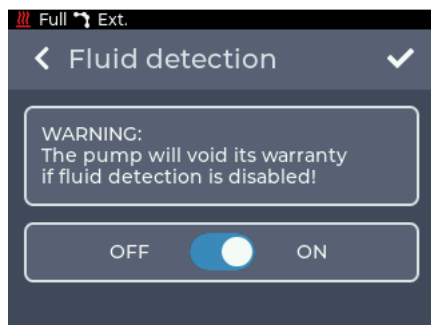

Fig. 31: Setting Fluid detection - On

The fluid detection is activated ex works.

The first switch-off is permanently stored in the background. Even if the fluid detection is switched on again later, it can be traced that the fluid detection was previously switched off.

If the switch is set to OFF and confirmed with ✓, the process must be finally confirmed again (see Fig. 32).

## 5. Operating the Cobra 3.1

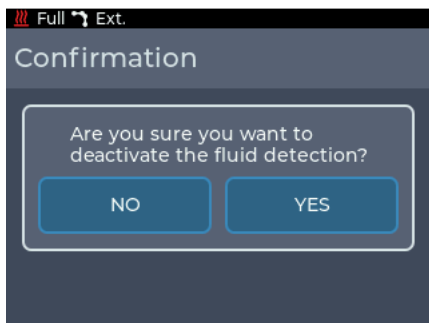

Fig. 32: Setting Fluid detection - confirmation

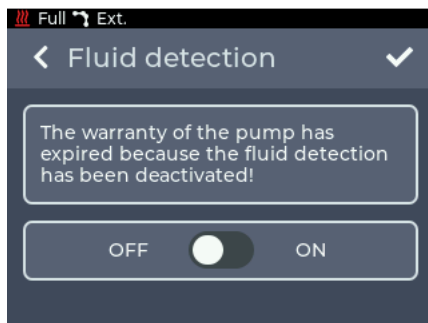

Fig. 33: Setting Fluid detection - Off

After the fluid detection has been switched off, a note to this effect is displayed (Fig. 33).

If an empty tank is detected during operation, a message to this effect is shown on the entire display.

### 5.6.6 Pump adjustment

In the **Pump adjustment** menu, the amount of fog can be adjusted in the range between 1 and 30 % to compensate for slight production tolerances in the pump output when operating multiple devices.

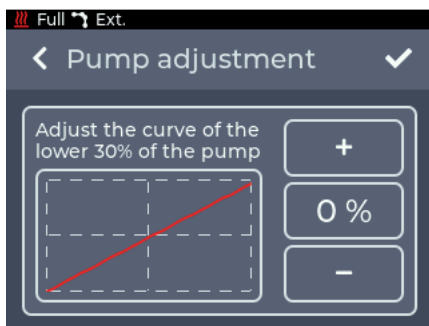

Fig. 34: Setting Pump adjustment

Due to production tolerances and signs of aging on each installed pump, the pump can be boosted or throttled.

When using multiple devices at the same time, differences in the amount of fog can be minimized with the pump adjustment.

- Pressing < in the upper left corner returns to the previous screen without saving the changes.
- Pressing ✓ saves the settings and returns to the main menu.

### 5.6.7 Standby

Tapping Standby displays the standby screen (see section 5.4.3).

## 5. Operating the Cobra 3.1

### 5.6.8 Info

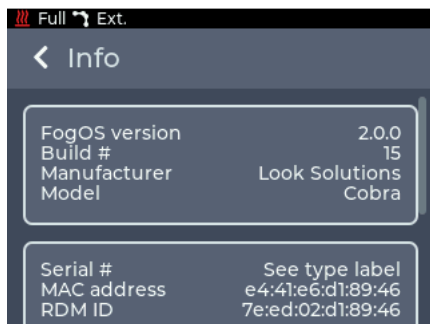

Fig. 35: Menu Info

The **Info** menu displays information about the device. This includes the model, the software version and the MAC address and RDM ID.

**Additional information** such as hour counters and temperatures can be found under Additional Information at the bottom of the menu.

**Licence information** can be found under Licence Information.

### 5.6.9 Update

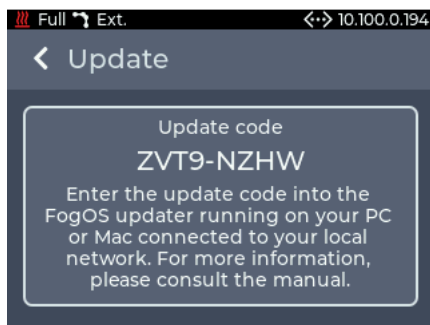

The current update code for the machine is displayed in the **Update** menu.

This can be used to start the update process, see section 5.8.

Fig. 36: Menu Update

### 5.6.10 Reset

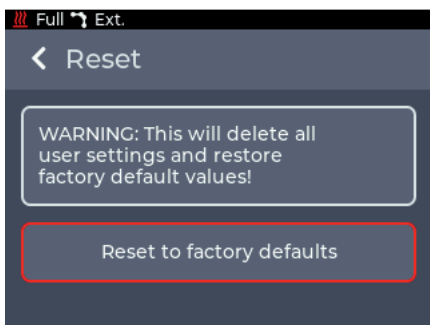

In the **Reset** menu, the unit can be reset to the factory defaults.

After pressing **Reset to factory defaults**, the unit is restarted and the factory settings are loaded.

The following settings cannot be reset:

- Operating hours counter
- Fluid detection counter

Fig. 37: Menu Reset

## 5. Operating the Cobra 3.1

### 5.7 DMX channel assignment

The DMX channel assignment depends on the set Personality (see section 5.6.2, p. 26).

Mode			DMX Value	Function	Type of control
1	2	3			
1	1	1		<b>Fog output</b>	
			0 - 255	0 to 100%	proportional
			0 - 255	0 to 30% if curve is set to continuous	proportional
*	2	2		<b>Fog/Pump curve</b>	
			0 - 64	Continuous	step
			65 - 129	Flood	step
			130 - 194	Extended	step
			195 - 255	Impulse	step
*	*	3		<b>Control</b>	
			0 - 25	Reserved	
				To activate the following functions, stop at DMX value for at least 5 sec. and fog output must be 0 for at least 1 sec.	
			26 - 100	Activate standby	step
			101 - 255	Deactivate standby	step

## 5. Operating the Cobra 3.1

### 5.8 Software-Update

The **FogOS Updater** is required to update the unit. The software runs on computers with Windows or MacOS. The computer and the **Cobra 3.1** must be connected to the same network and the computer must have an active internet connection.

#### Note

If the computer has a wireless Internet connection, the unit can also be connected directly to the computer with a network cable. The operating system must support Auto IP for this (standard for modern operating systems)!

The unit displays an update code under **Settings** -> **Update** (section 5.6.9, fig. 36). This must be entered in the FogOS Updater.

If the unit is found in the network and an update is available, the **Cobra 3.1** is put into update mode.

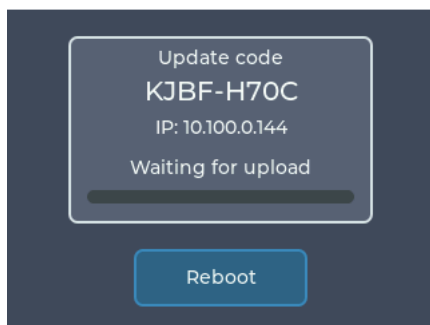

Fig. 38: Update-Modus

The update is automatically uploaded and installed. Afterwards the device restarts.

#### Note

If no software for operation is found on the device, it is automatically switched to update mode.



## 6. Troubleshooting and Error messages

### 6.1 Malfunction during operation

- The fog machine does not fog
  - Check external controls
  - Check power source
  - Check fluid quantity
  - Check connection at fluid tank for tightness/clogging
  - Check fluid hose for leaks
  - Check sinter filter for contamination
  
- The fog machine fogs uncontrollably
  - Check external controls
  - Inspect for condensation on electrical parts (condensation in the unit can trigger the fogging process).
  
- The fog machine switches off suddenly
  - Temperature monitor has shut off due to overheating. Remove external heat source(s) and provide sufficient air supply. The machine will then switch on again after approx. 15 - 30 min.
  
- Loud humming noise/clacking when fogging
  - The pump runs dry. This should be avoided at all costs!
  - Refill fluid
  - Check hose coupling and engage again. Exchange tank lid if needed.
  
- The fog machine does not fog as expected
  - Check the set pump characteristic -> see point 5.6.1

## 6. Troubleshooting and Error messages

### 6.2 Error messages

If an error appears on the display, contact your dealer or the manufacturer. After the error has been corrected, the **Cobra 3.1** must be restarted in order to continue using it. The device can report the following errors:

#### ERROR E-1

Temperature sensor 1 is  
broken / disconnected

Please contact the manufacturer  
or your local dealer for support.

#### ERROR E-2

Temperature sensor 2 is  
broken / disconnected

Please contact the manufacturer  
or your local dealer for support.

#### ERROR E-3

Temperature sensors are  
broken / disconnected

Please contact the manufacturer  
or your local dealer for support.

- **E-1** : The temperature sensor in the front area of the heating element is defective or not connected.
- **E-2** : The temperature sensor in the rear area of the heating element is defective or not connected.
- **E-3** : Both temperature sensors are defective or not connected.
- **E-4** : The temperature on the circuit board is too high.

**Note:** These error messages can also occur if there is a loose contact on one of the temperature sensors!

## 7. Cleaning, Care and Maintenance

- Make sure that the ventilation slots are not clogged with dust deposits. If necessary, clean the ventilation slots (also underneath the machine).
- Avoid overheating the unit by maintaining the operating ambient temperature. For example, do not let spotlights shine directly on the unit.
- Avoid running the **Cobra 3.1** without fluid. Otherwise the pump will run dry.
- Wipe up leaked fluid immediately. Moisture - including fluid - can destroy the electronics.
- Check the condition of the sinter filter from time to time, clean or replace if necessary.
- If the same fluid canister is used frequently, you should rinse it thoroughly before filling with fresh fluid. This will prevent contamination and premature deterioration of the fluid.
- If the **Cobra 3.1** is permanently installed, ensure that a mist-free air supply is permanently guaranteed. Cooling air with too high a mist concentration can condense in the machine and cause electrical damage.  
The tank holder can be unscrewed for permanent installation. Caution: The difference in height between the external canister and the machine should not exceed 1.5 metres, otherwise the pump cannot suck in the fluid!
- If necessary, clean the surface of the machine with a suitable, solvent-free cleaning agent (e.g. PURE Equipment Cleaner).
- **PLEASE NOTE:** The vaporizer/heating element of our units does **NOT** need to be cleaned! Cleaning liquids offered on the market, so-called cleaners, can damage the vaporiser! In this case, the guarantee will be void.

## 8. Specifications

Procedure:	Vaporizing fog generator
Power requirement:	3100 Watt*
Voltage:	220 - 250V/ 50 Hz
Warm up time:	approx. 15 min.
Fluid consumption, measured with Look Regular-Fog:	at max. output      260 ml/min at cont. output      46 ml/min
Fluid tank capacity:	5 Litre
Fog output:	adjustable in 99 steps of 1%
Output projection:	max. 25 m
Fogging time:	at 100% output: Extended-Mode approx. 55 sec. Impulse-Mode approx. 22 sec. at ≤ 30% output: continuous output
Control:	Manual 0 - 10 V analog DMX 512 Ethernet (Artnet, sACN) Timer Radio remote (optional) XLR-remote (optional)
Temperature control:	Microprocessor controlled
Overheating protection:	Heater block/Thermostat Pump/Thermal switch
Dimensions (L x W x H):	58 x 27 x 26 cm
Weight incl. tank:	23 kg

\*also available as 90 - 125V/60 Hz version with 1800 Watt. Data such as heating time, fluid consumption and fogging time differ.

Manufactured in Germany for:

**Look Solutions GmbH & Co. KG** • Bünteweg 33 • D - 30989 Gehrden • [www.looksolutions.com](http://www.looksolutions.com)

## 9. Warranty conditions

For the fog machine **Cobra 3.1** Look' guarantee is:

1. Free of charge, subject to the following conditions (No. 2 - 6) we will repair any defect or fault in the unit if it is caused by a proven factory fault and has been advised immediately after appearance and within 24 month of delivery to the end user. Insignificant deviations of the regular production quality does not guarantee replacement rights, nor do faults or defects caused by water, wrong fog fluid, by generally abnormal environment conditions or Force Majeure.
2. Guarantee Service will be done in the following way: Faulty parts will be repaired or replaced (our choice) with correct parts. Faulty units have to be brought to us or our service centres or to be sent to us or our service centres at customer's expense. The invoice and/or receipt showing the purchase date and the serial number has to come with the faulty unit, otherwise this will not be guarantee service. Replaced parts become our property.
3. The customer loses all rights for guarantee services, if any repairs or adjustments are done to the units by unauthorized persons and/or if spare parts are used which are not approved by us. The right of guarantee service is also lost if fluids other than original Look fog fluids have been used or if units are sent to us with full fluid bottles. Also non compliance with the instructions in this manual or mistakes by incorrect handling/treating of the machine will lead to a loss of guarantee and also any faults and damages caused by undue force.
4. Certain parts of the machine are „consumable parts“ and are not covered by the warranty.
5. Guarantee services do not cause an extension of the guarantee time or the start of a new guarantee time. The warranty for replaced parts ends with the guarantee time of the whole unit.
6. If a defect/fault can not be repaired by us in a satisfactory time, we will, within 6 months after sale of the unit, on choice of the customer, either:
  - replace the whole unit for free or
  - refund the lesser value or
  - take back the whole unit and refund the purchase price, but not more than the usual market price at the time of the refund.
7. Further claims, especially for damages, losses etc. outside the unit are excluded.

Other guarantee regulations may be valid outside Germany. Please check with your dealer!

If you should send the unit for service, do not forget to remove any liquid from the fluid bottle.

